



PACKAGING  
**COMFORT.PACK** IS  
WHEN PRODUCTIVITY AND  
ERGONOMICS MERGE.



Storopack – SPECIALIST IN PROTECTIVE PACKAGING AND PACKAGING PROCESSES	3
COMFORT.PACK OVERVIEW	4
CONSULTING AND SERVICE	6
Storopack PROCESS	8
COMFORT.PACK	10
PRODUCT PORTFOLIO	14
COMFORT.PACK Table	15
RACK AND DRAWER SYSTEMS	16
EXTENSIONS	17
FLEXIBLE PROTECTIVE PACKAGING	18
OFFICE ACCESSORIES	20
LIGHTING AND SCALES	22
ADDITIONAL ACCESSORIES	23
CUSTOMIZATION	24
CUSTOMER CASE STUDIES	26

As of: 2022

**1874** Founded as a tannery

**1959** Storopack Hans Reichenecker GmbH + Co. is founded; Production of technical molded parts made from Styropor®



**72** locations

**612** million Euros in revenue

**2,310** employees



PERFECT PROTECTIVE PACKAGING®

## PERFECT PROTECTION MEANS BEING EQUIPPED FOR ANY SITUATION.

Storopack is a specialist in protective packaging. Our promise is to provide “Perfect Protective Packaging” to optimally protect every product while in transit. We think holistically, advising our customers on how to make the packaging process more efficient and, if desired, integrating tailored solutions. Our comprehensive range covers all of the requirements associated with optimal product protection. With 2,310 employees at certified production facilities and locations in 18 countries, we maintain a decentralized structure and are always in direct vicinity to our customers.

### OUR STRENGTHS – YOUR ADVANTAGE:

- ▶ OWNER-MANAGED FAMILY COMPANY
- ▶ LOCAL CONTACTS
- ▶ INTERNATIONAL FOCUS
- ▶ RELIABILITY
- ▶ SERVICE AND CUSTOMIZED ADVICE
- ▶ HIGH PRODUCT DIVERSITY
- ▶ CONTINUOUS IMPROVEMENT OF PACKAGING PROCESSES
- ▶ PROCESS OPTIMIZATION
- ▶ COMPLETE SOLUTIONS ALL FROM A SINGLE SOURCE
- ▶ TURN-KEY SOLUTIONS WITH AUTOMATION PROCESSES

▶ **Storopack image film:** [www.storopack.com/perfect-protective-packaging](http://www.storopack.com/perfect-protective-packaging)

COMFORT.PACK BROCHURE



## COMFORT.PACK FOCUSES ON ERGONOMICS IN THE PACKAGING PROCESS.

Ergonomics at the workplace is important, because incorrect movements and unnecessary walking distances when packaging your products cost time and energy. And affect the health of employees in the long term. COMFORT.PACK from Storopack combines both: comfortable workflows and efficient processes. Unnecessary movements are avoided, as the packer always has all of the packaging materials conveniently within reach at an ergonomic height. The individually customised packing stations are ergonomically designed in line with the Storopack Working Comfort® principle and not only increase the productivity of your processes, but also the well-being of your employees. COMFORT.PACK stations prevent strain and thus increase satisfaction and motivation.

### INDIVIDUAL CONSULTING

Our experts analyze your existing packaging processes and come up with the right solution, taking into account ergonomic aspects. The focus here is on the efficiency of the processes and the well-being of your employees in equal measure.

The modular concept of the packing stations makes your packaging processes fit for the future: Based on the modular principle, the packing stations can be expanded at any time. They can always be adapted and integrated to the individual needs of the packers and the requirements of your packaging process.

### THE BENEFITS OF COMFORT.PACK

- ▶ PRODUCTIVE: FROM SHIPPING BOXES TO PROTECTIVE PACKAGING AND LABELING, COMFORT.PACK CAN COMBINE ALL PACKING FUNCTIONS, SAVING TIME AND WALKING DISTANCES
- ▶ USER-FRIENDLY: ERGONOMICALLY DESIGNED IN ACCORDANCE WITH THE Working Comfort® PRINCIPLE
- ▶ CUSTOMIZABLE: THANKS TO THE MODULAR PRINCIPLE, EACH COMFORT.PACK station IS ADAPTED TO THE CUSTOMER'S NEEDS; EACH SOLUTION IS DEVELOPED INDIVIDUALLY
- ▶ VARIABLE: COMPREHENSIVE SOLUTIONS FOR ALL OF STOROPACK'S PACKAGING MATERIALS: AIRplus®, PAPERplus®, PAPERbubble®, FOAMplus® AND Loose Fill
- ▶ ELEGANT: USE OF HIGH QUALITY AND VISUALLY APPEALING MATERIALS; POSSIBILITY TO CHOOSE CUSTOMIZED COLORS OR LOGO ENGRAVINGS







CONSULTING AND SERVICE

**SERVICE** MEANS  
FOCUSING ON CUSTOMERS'  
REQUIREMENTS.



**GOOD CONSULTING** MEANS  
DEVELOPING TAILORED SOLUTIONS.

## 05 SERVICE

Our services are not limited to personal support from our specialists and on-site service. We permanently inform our customers about new technologies, materials and processes and advise them on the further development of existing packaging processes. Thanks to our large global service structure, Storopack is always at your side.

## 04 DELIVERY

Storopack's experts install the COMFORT.PACK station professionally and train the operators thoroughly. This ensures optimal use of the solution and the corresponding protective packaging.

## 03 PRODUCTION

Under constantly monitored quality standards, we produce the developed COMFORT.PACK station in our Storopack Service Centers in Germany and the USA and in cooperation with our partners.

## 01 ANALYSIS

The analysis phase is integral to the success of this process. We take a close look at the customer's objectives as well as the products to be packaged, the packaging materials currently used, means of transport and the organization of the existing packaging process.

## 02 PROCESS AND PRODUCT DEVELOPMENT

Using the findings of this analysis, concrete measures are planned to optimize the packaging process and the material. To illustrate the individual development, we create a detailed 3D visualization showing the planned solution. We use standard products from our portfolio or, if required, work with products that go beyond our existing product range.

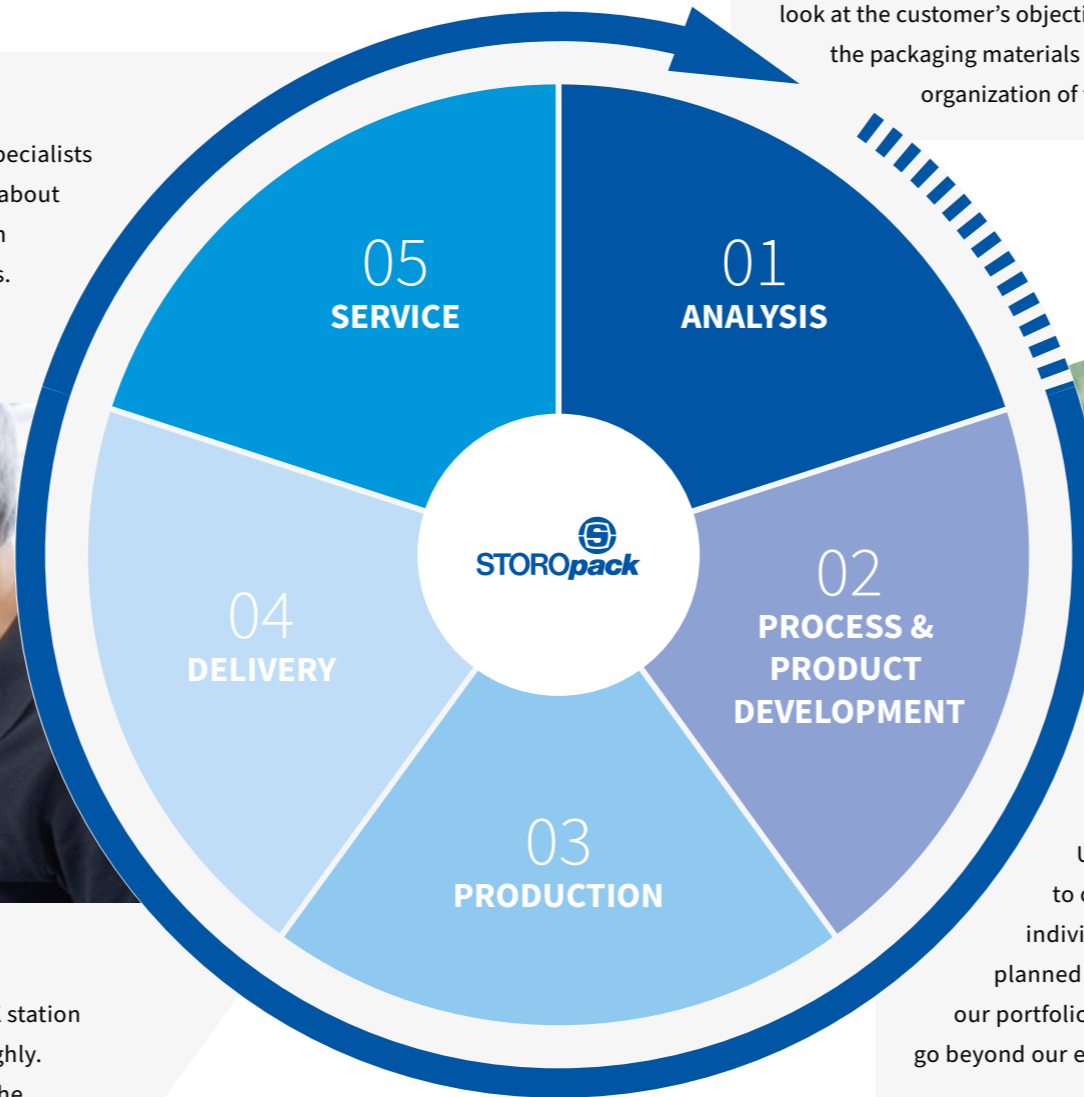





COMFORT.PACK

**VARIETY** IS  
OFFERING THE APPROPRIATE  
SOLUTION FOR EACH  
CHALLENGE.



# COMFORT.PACK MEANS, BEING MORE PRODUCTIVE WITH ERGONOMIC PACKING STATIONS.

Ergonomic workstations and efficient processes - with COMFORT.PACK Storopack increases the productivity of the protective packaging process. Thanks to the modular design principle and an extensive selection of

accessories, our experts develop the right solution for every challenge. In addition, individual fabrications are possible for special customer-specific requirements.

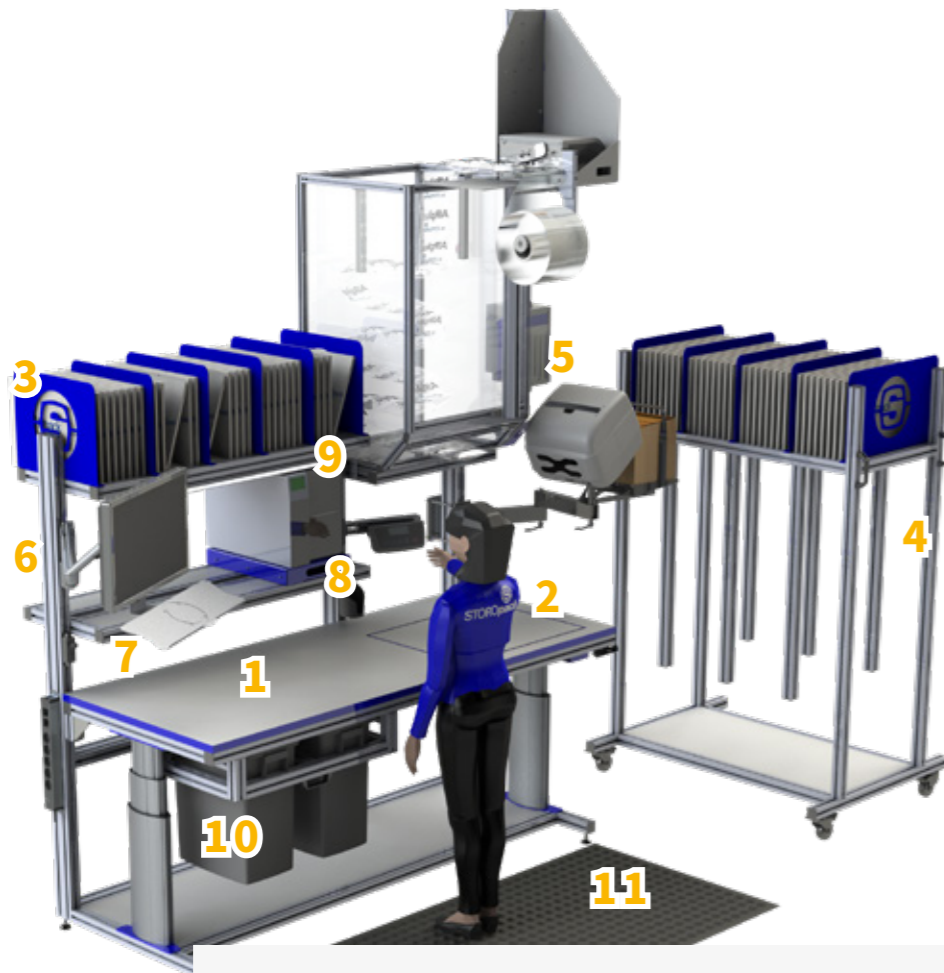

	<b>PAGE</b>
1. COMFORT.PACK Table	15
2. SCALE CUTOUT	15/22
3. RACK SYSTEM	16
4. MOVABLE RACK SYSTEM	17
5. FLEXIBLE PROTECTIVE PACKAGING	18
6. FOLDING ARM MONITOR	20
7. FOLDING ARM KEYBOARD	20
8. PRINTER PULL-OUT	21
9. LIGHTING	22
10. PULLOUT FOR BINS	23
11. ERGONOMIC WORKING MAT	23

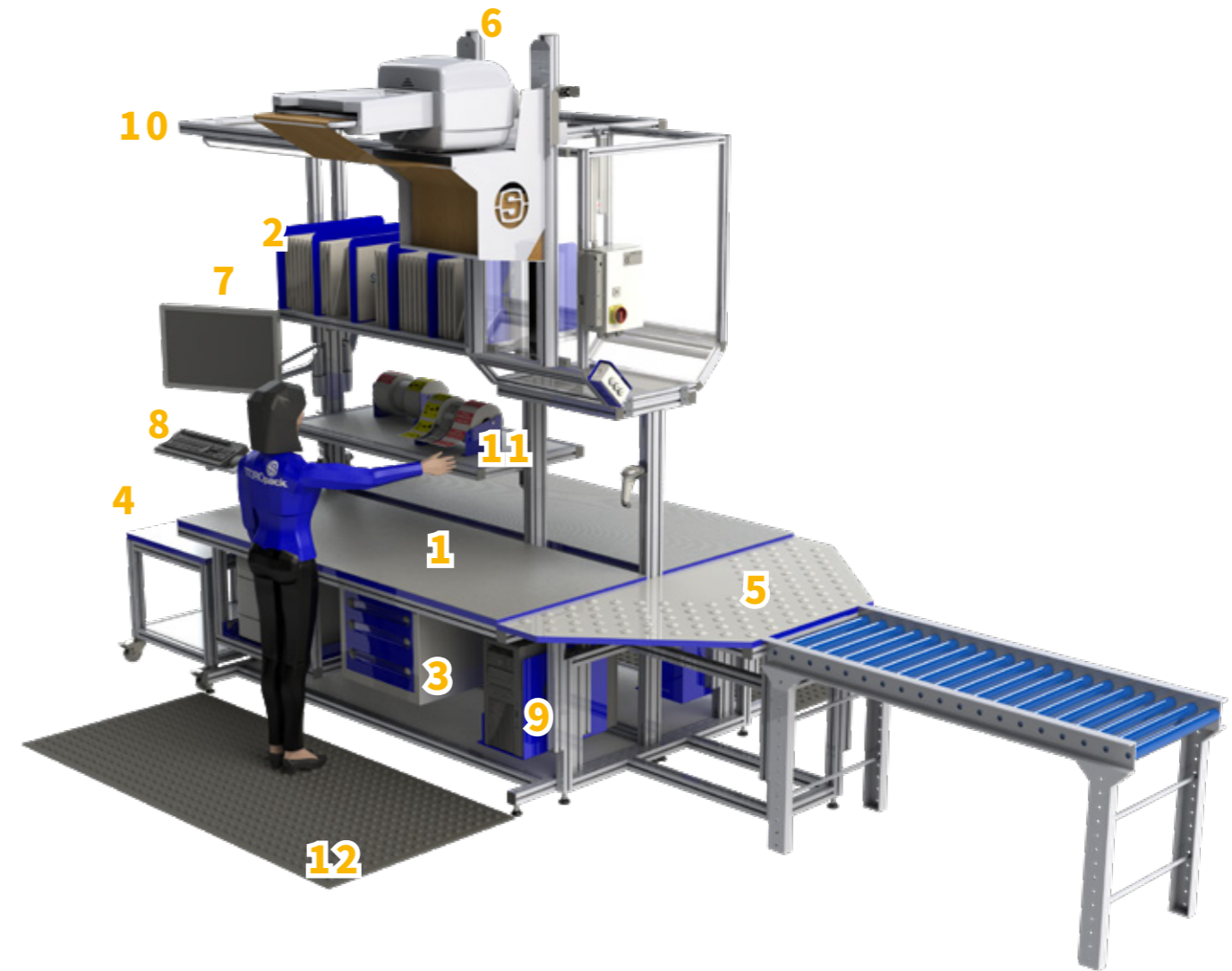

	<b>PAGE</b>
1. COMFORT.PACK Table	15
2. RACK SYSTEM	16
3. UNDERBENCH UNIT	17
4. SIDE TABLE	17
5. TRAPEZOIDAL TABLE WITH BALL ROLLERS	17
6. FLEXIBLE PROTECTIVE PACKAGING	18
7. FOLDING ARM MONITOR	20
8. FOLDING ARM KEYBOARD	20
9. COMPUTER HOLDER	20
10. LIGHTING	22
11. LABEL DISPENSER	23
12. ERGONOMIC WORKING MAT	23

More products on the following pages.

## PRODUCT PORTFOLIO

### FLEXIBILITY IS WHEN THE EQUIPMENT IS CUSTOMIZABLE TO YOUR NEEDS.

Storopack has a wide selection of products to build the ideal COMFORT.PACK station for different needs. Our experts work closely with customers to develop the perfect solution. The products and solutions are tailored specifically to your requirements. We support you until you achieve the ideal results.

## COMFORT.PACK TABLE

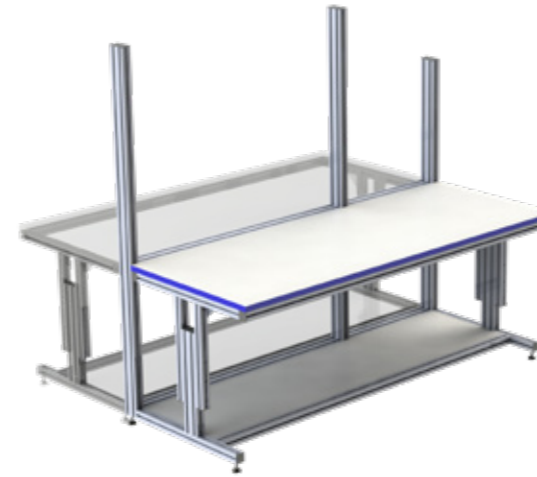

### COMFORT.PACK Table

The COMFORT.PACK table convinces with a durable, moisture- and scratch-resistant chipboard according to EN 312. The HPL (High Pressure Laminate) coating on both sides according to DIN EN 438 makes the table particularly robust. The protection of the packer as well as the table edge is ensured by the blue ABS edging. Depending on customer requirements, this can also be designed with individual colors. The table thickness is 26.6 mm. Configuration as single or double packing station is possible. Optional manual or electric height adjustment. The maximum load capacity of the manually height-adjustable table is 600 kg.

### STANDARD SIZES

Individual dimensions possible upon request.

2000 x 800 mm	1200 x 800 mm
2000 x 650 mm	1200 x 650 mm
1600 x 800 mm	700 x 800 mm
1600 x 650 mm	700 x 650 mm

## EQUIPMENT TABLE TOP



### SCALE CUTOUT

Cutout for scale; ideal for space-saving integration of a scale directly in the packing table.



### BALL ROLLERS

Equipment of the table surface with ball rollers to support box movements (load capacity per roller 35 kg).

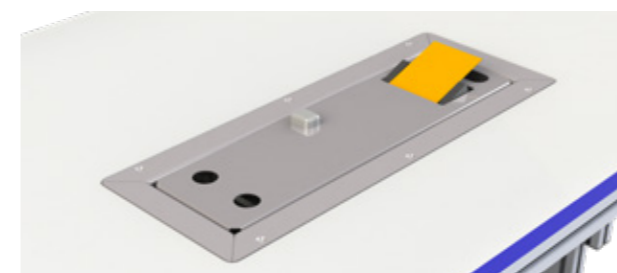

### WATER ACTIVATED TAPE DISPENSER

Space-saving, recessed into the table top for greater ergonomics and efficiency. For applying water activated tape directly to the carton by sliding it over the dispenser or for dispensing water activated tape strips.



# MAKE YOUR COMFORT.PACK TABLE A COMFORT.PACK STATION

## RACK AND DRAWER SYSTEMS

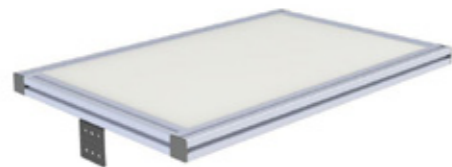

### RACK SYSTEM I

Sturdy rack with scratch-resistant melamine resin coating for storage of necessary work tools.



### RACK SYSTEM II

Sturdy cardboard box rack with scratch-resistant melamine resin coating and dividers for storing shipping boxes. The dividers are individually adjustable.

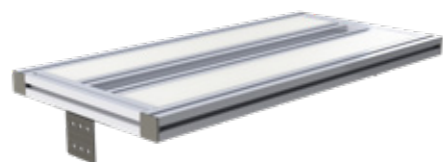

### RACK SYSTEM III

Sturdy rack with scratch-resistant melamine coating. Cable channel equipped with brushes, keeps the cables in place.



### UNTERBENCH UNIT

Lockable underbench unit for storing shipping supplies for an organized appearance. Available with one or three drawers. Maximum 35 kg load capacity.



### MOVABLE RACK SYSTEM

Optimal for storing large cardboard boxes close to the workplace. Rollers allow flexible positioning of the shelf. Individual dimensions possible.

## EXTENSIONS



### SIDE TABLE

Flexible extension for a packing station with HPL (High Pressure Laminate) coating on both sides. Can be planned next to or integrated into the packing table.

- ▶ WITHOUT ROLLERS
- ▶ WITH ROLLERS
- ▶ SURFACE WITH BALL ROLLERS



### TRAPEZOIDAL TABLE WITH BALL ROLLERS

Ideal for the integration of a double packing station into a central conveyor system. The movement of the packed shipping boxes is optimally supported by the ball rollers.



For organized work:  
COMFORT.PACK, equipped  
with rack system and unterbench unit



## FLEXIBILITY IS WHEN THE PACKAGING ADAPTS TO THE GOODS AND NOT THE OTHER WAY AROUND.

COMFORT.PACK and protective packaging material go hand in hand: whether it's loose fill, foam, air pillows, or paper cushioning. Storopack's AIRplus®, PAPERplus®, PAPERbubble®, FOAMplus®, or Loose Fill offer just the right solution.

### DESIGNED BY STOROPACK

We provide you with our extensive selection of protective packaging and also our decades of experience. We offer detailed advice and work with you to develop an appropriate solution featuring products from our large range.

### SUSTAINABLE AND RESOURCE-SAVING

When it comes to choosing protective packaging, the benefits and functions of our products play a crucial role. That's because whenever a product is damaged in transit, resources are consumed unnecessarily due to new production and additional transport, thus harming the environment.

Additionally sustainable raw materials are a great way to protect the environment and natural resources. Our product portfolio therefore already includes many products that are made using recycled or renewable raw materials.



 [More about Flexible Protective Packaging from Storopack:](https://www.storopack.com/products/flexible-protective-packaging)  
[www.storopack.com/products/flexible-protective-packaging](https://www.storopack.com/products/flexible-protective-packaging)

## INTEGRATION OF PROTECTIVE PACKAGING AT THE COMFORT.PACK station



### SILO

Stable, durable solution for stocking paper or air cushions for fast and ergonomic removal. This ensures automatic production and continuous availability of packaging pads. The protective packaging system can be lowered to the individual working height for convenient paper or air cushion roll change thanks to a lift system. Different silo sizes and configurations for multiple packers are available depending on requirements. Our experts will provide detailed advice upon request.

Can be used to integrate the following products:

- ▶ PAPERplus® Papillon
- ▶ PAPERplus® Track
- ▶ AIRplus® Mini

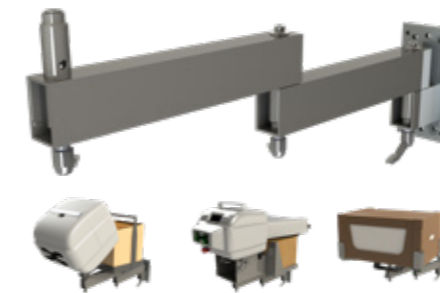

### SWIVEL ARM

Flexible, space-saving swivel arm for ergonomic removal of paper pads.

Can be used to integrate the following products:

- ▶ PAPERplus® Papillon
- ▶ PAPERplus® Track
- ▶ PAPERbubble®

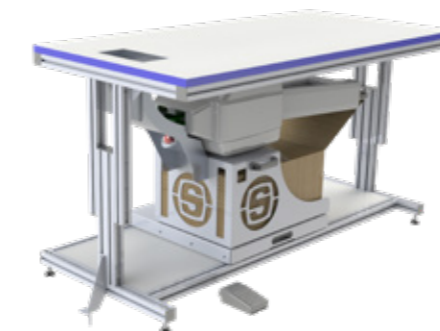

### UNDERTABLE PULL-OUT

For space-saving storage of packing material and machine under the table. The paper pads are dispensed through an opening in the tabletop. A convenient paper change is made possible by the pull-out function.

Can be used to integrate the following products:

- ▶ PAPERplus® Track



### UNDERBENCH UNWINDING UNIT

For space-saving storage of packing material under the table. The cutting unit on the table enables ergonomic cutting.

Suitable for:

- ▶ PE FOAM FOIL
- ▶ PACKING PAPER
- ▶ CONVENTIONAL BUBBLE WRAP



## OFFICE ACCESSORIES



### FOLDING ARM MONITOR

Continuously adjustable support arm for a monitor up to 15 kg. Individually rotatable and tiltable.



### ADAPTER KEYBOARD

Support arm for keyboard and mouse with connector for attachment to monitor folding arm.



### FOLDING ARM KEYBOARD

Continuously adjustable support arm for keyboard and mouse for individual adjustment. Rotates, swivels and tilts for the optimal working position.

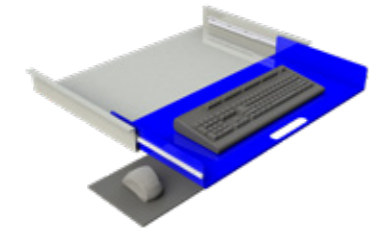

### UNDERBENCH KEYBOARD DRAWER

Continuously adjustable pull-out for keyboard for installation under the table top. Optionally with or without mouse tray.



### COMPUTER HOLDER

Computer holder for devices up to 230 mm wide to be installed on the table.



### THIN CLIENT HOLDER

Computer mount for thin client devices of 35 - 53 mm width for mounting between support element and monitor. Can also be installed on the table.

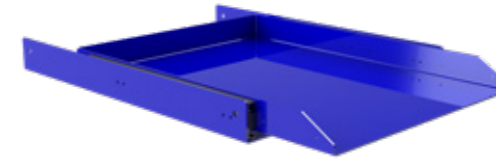

### PRINTER PULL-OUT FOR A4 PRINTER

Ideal for integrating a printer for printing shipping documents directly at the packing station.



### PRINTER PULL-OUT FOR LABEL PRINTER

Optimal for printing shipping labels directly at the packing station.

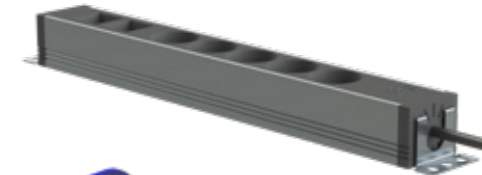

### POWER STRIP

Available in different country versions.

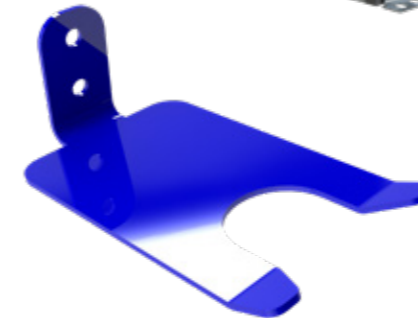

### EQUIPMENT HOLDER

For convenient storage of handheld scanners or tape dispensers.



Perfectly equipped:  
COMFORT.PACK with PC and keyboard



## LIGHTING



### LED WORKSPACE LIGHTING

Lighting for installation under a shelving system or above the packing station.  
Our experts will advise you on the optimal illumination of the workstation.

## SCALES

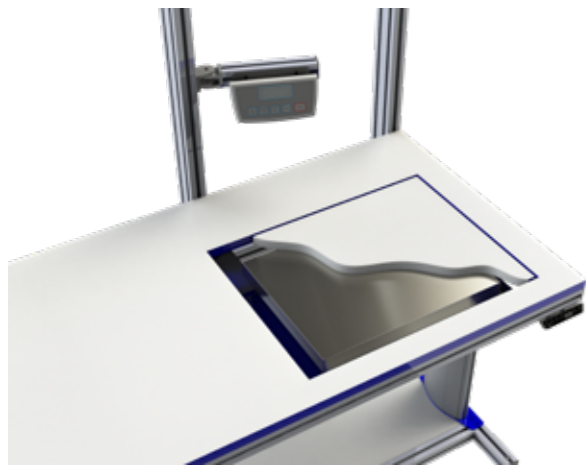

### SCALE

Can be placed on the tabletop or recessed into the tabletop.  
An external display mounted at ergonomic height at the station allows ideal operation.  
Dust and splash-proof according to IP65 standard; optionally with or without calibration.

## ADDITIONAL ACCESSORIES

### LABEL DISPENSER

Optimal for providing label rolls.

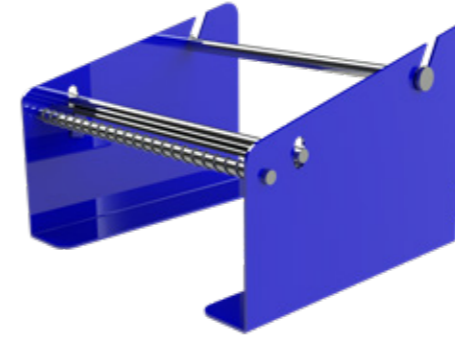

### GRIDDED CUTTING MAT

Worktop protector with grid, available in green or gray in a wide range of dimensions. Reduces sliding movement on the table.

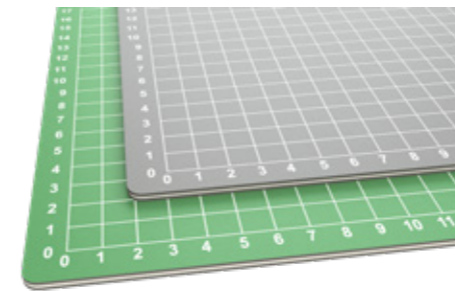

### ERGONOMIC WORKING MAT

Accessories for the prevention of fatigue and appearances. Beveled edges reduce the risk of tripping.

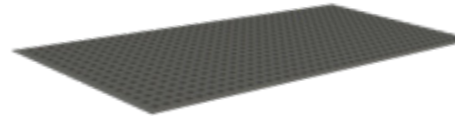

### PULLOUT FOR BINS

Waste disposal directly at the workplace thanks to garbage cans that can be pulled out from under the table. Available for one or two bins with different capacity.

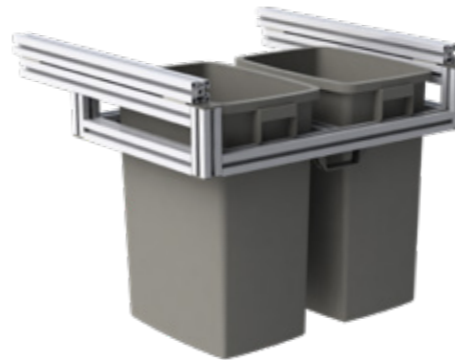

### CART FOR BINS

Customizable trolley for waste garbage cans, each with two swivel and brake casters. Available with one, two or three plastic bins.



Keeps the workplace organized:  
COMFORT.PACK with  
underbench unit, bin and printer pull-out



# INDIVIDUAL IS WHEN THE CORPORATE DESIGN IS ALSO IMPLEMENTED AT THE PACKING STATION.

COMFORT.PACK is tailored to the customer's needs and developed individually. The design of the COMFORT.PACK station is as unique as its configuration. To ensure that the corporate design is also optimally implemented at the packing station, a large number of elements can be equipped in desired colors or with freely selectable logos. Thanks to laser cutting, almost all shapes can be cut out

precisely and cleanly. There are also virtually no limits in terms of color: even elements in different colors can be placed at a packing station.

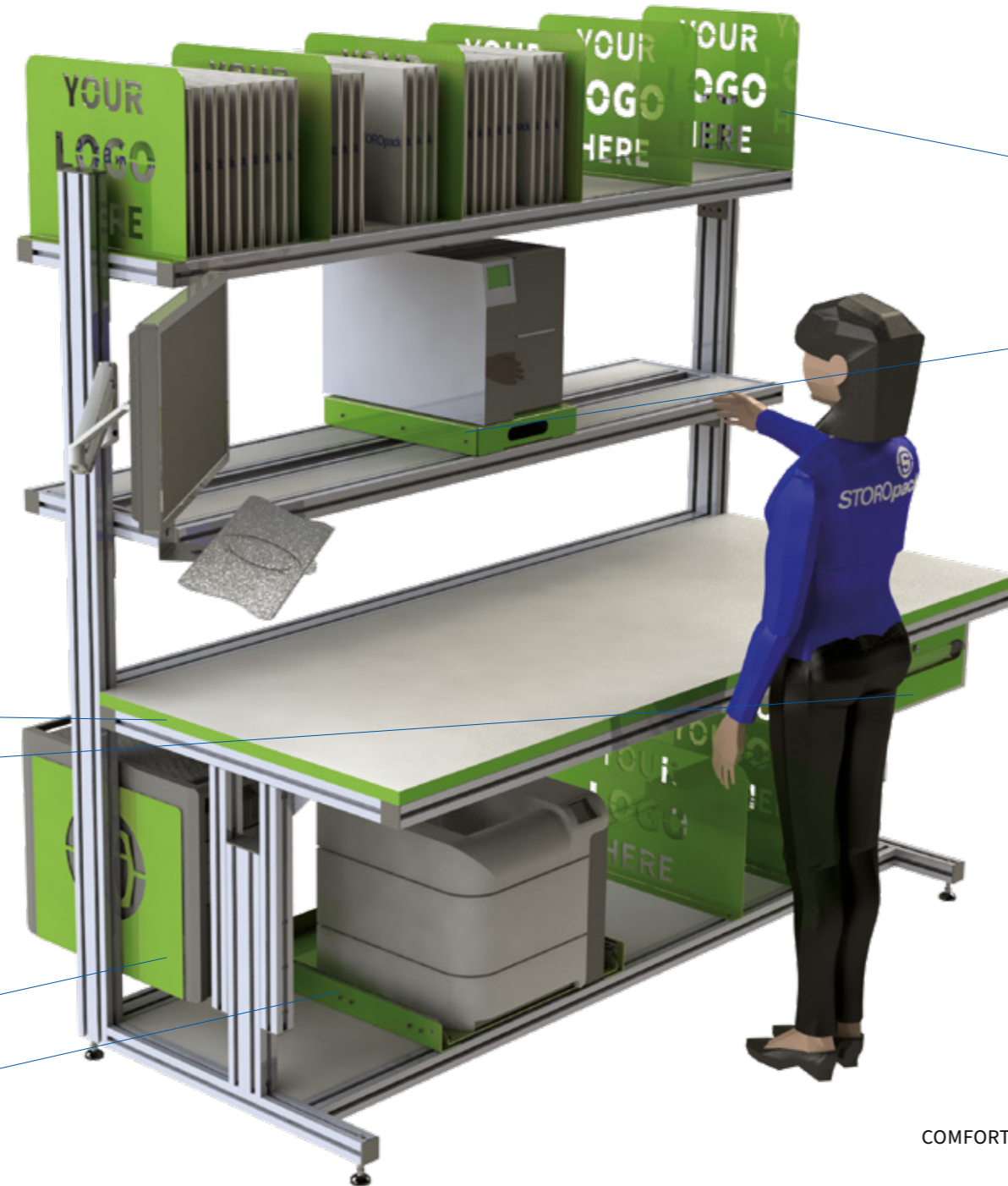

## CUSTOMIZABLE ELEMENTS

Divider

Printer Pull-Out for Label Printer

## CUSTOMIZABLE ELEMENTS

ABS-Edges

Underbench Unit with Drawers

Holder for Computer

Printer Pull-Out for A4 Printer

## Customizable and Individual:

COMFORT.PACK can be equipped with customer-specific colors and logos.





Customer Case Studies

## VELLY – PAPERplus® Chevron SEMI-AUTOMATIC AND ERGONOMIC

„We were very impressed by the overall concept and the fact that Storopack provides everything we need.“

ANTONIO CHIARELLO,  
CEO VELLY

The company Esterline Connection Technologies – SOURIAU – SUNBANK in France designs, manufactures and markets interconnection solutions for severe environments. With an integrated distribution line consisting of four height-adjustable COMFORT.PACK stations and a strapping machine a maximum of 700 packages a day are shipped. The packaging material – AIRplus® Void air pillows – is stored in a central COMFORT.PROTECT silo that makes it easily accessible for all packers.

▶ **Video:** [www.storopack.com/souriau-video](http://www.storopack.com/souriau-video)



More than 350 hair salons are franchisees of the Velly company. These are supplied with hair care products from around 18 brands from the company's headquarters in southwest Germany. To ensure the shipping goods are perfectly protected and reach the partners on time, the packaging process needs to be seamless. Storopack has made the process even more efficient with the integration of four COMFORT.PACK stations, which has ultimately increased packaging performance by 65 percent, from 60 to 99 boxes per minute.



Storopack optimized the packaging process with a comprehensive concept that, as requested, accommodated the current location of the existing shelves. At four state-of-the-art packing stations, up to eight employees can pack the picked goods in boxes, block and brace them with PAPERplus® Chevron paper cushions, and secure the packages with water-activated tape. These are then automatically transported via powered conveyor belts. The system registers the shipping label with cameras, sorts the packages according to shipping company, and sends them on their way. A practical feature is that the height is measured in the final step, with larger boxes wrapped prior to discharge and smaller packages simply allowed to pass through.

▶ **Video:** [www.storopack.com/velly](http://www.storopack.com/velly)

Customer Case Studies

## SOURIAU – AIRplus® 40 PERCENT MORE PRODUCTIVE







If you would like to obtain additional information or speak to us directly, please feel free to get in touch with us. At Storopack we are happy to help.

**Storopack Deutschland GmbH + Co. KG**

Untere Rietstrasse 30  
72555 Metzingen  
Germany

Africa & Middle East	+49 7123 164-0
Asia-Pacific	+852 3421 2392
Europe	+800 7867 6722
North America	+1 800 827 7225
South America	+55 11 5677 4699

[info@storopack.com](mailto:info@storopack.com)  
[www.storopack.com](http://www.storopack.com)